

Specifications

Display Technology	Liquid Crystal Display
LCD Panel	3x0.64" (16:10)
Brightness (ISO lumens)	6500 Lumens
Resolution	WUXGA (1920 x 1200)
Number of pixels	2,304,000 (1920 x 1200)x3, total of 6,912,000 pixels
Contrast	3500000:1
Center to corner uniformity	> 90%
Lens	F1.6~1.9, f=15.31~24.64mm, Manual zoom (1.6x), Manual focus
Screen size	30"-300"
Throw distance	0.68 m ~ 10.84m
Throw Ratio	1.05 - 1.68
Light Source (Service life)	Laser diode (Normal mode: 20000h, Eco mode: 25000h)
Lens Shift	Vertical: ±40% (Manual), Horizontal: ±10% (Manual)
Keystone Correction	Vertical: ±40° (Auto, Manual), Horizontal: ±15° (Manual)
Input Terminals	PC: DVI-D x1, VGA (D-sub 15pin)x1 Audio: Audio in: mini jack x1 (3.5mm) Video: HDMI x1, Video x1 (RCA) Other: USB x2
Output Terminals	VGA (D-sub 15pin) x1, Audio out (Mini-jack) x1 (3.5mm)
Control Terminals	Rs232 (D-sub 9pin) x1, RJ-45 x1 (Control)
PC input signal	PC-VGA, SVGA, XGA, SXGA, WXGA, UXGA, WUXGA / Mac
Video input signal	PAL, SECAM, NTSC (480i, 480p, 576i, 576p, 720p, 1080i, 1080p)
Scanning Frequency	Horizontal: 15~90kHz, Vertical: 24~85Hz
Noise	Normal mode: 37dB, Eco mode: 29dB
Projection Method	Ceiling/floor, front/rear (Auto Image Rotation)
Speaker	10W x 1
Weight	9.5 Kg
Dimension (WxHxD)	545 x 128 x 345mm (not incl. protruded part)
Power Consumption	100~240V AC (50/60Hz)
Standby power consumption	460W max (≤ 0.5W when standby mode set to Eco)
Operating Environment	Operating temperature: 0°C~40°C, Operating humidity: 20%~80% (non-condensation)
Standard accessory	Wireless remote control, power cord
Functions	<ul style="list-style-type: none"> Built-in LAN for remote monitoring DICOM simulation mode Overheat automatic shutdown function Quick start and Quick off One-button black screen function Quiet 29dB (Eco mode) Compatible with PJ-Link `AMX `Crestron Password locking and anti-theft lock latch Blackboard modes for colored screen surfaces USB Memory Viewer



VIN-U7A

Specifications Sheet

Projection Distance

XGA (4:3 aspect ratio)

Screen Size (inch)	Min. (wide)(meter)	Max. (tele)(meter)
30"	0.70	1.12
60"	1.45	2.34
86"	2.03	3.31
100"	2.30	3.70
120"	2.85	4.64
150"	3.50	5.60
180"	4.37	7.04
200"	4.70	7.50
300"	7.00	11.04

WXGA (16:10 aspect ratio)

30"	0.68	1.09
60"	1.43	2.31
86"	2.05	3.31
100"	2.26	3.61
120"	2.87	4.62
150"	3.39	5.43
180"	4.30	6.93
200"	4.53	7.24
300"	6.78	10.84



Dimension (Unit: mm)

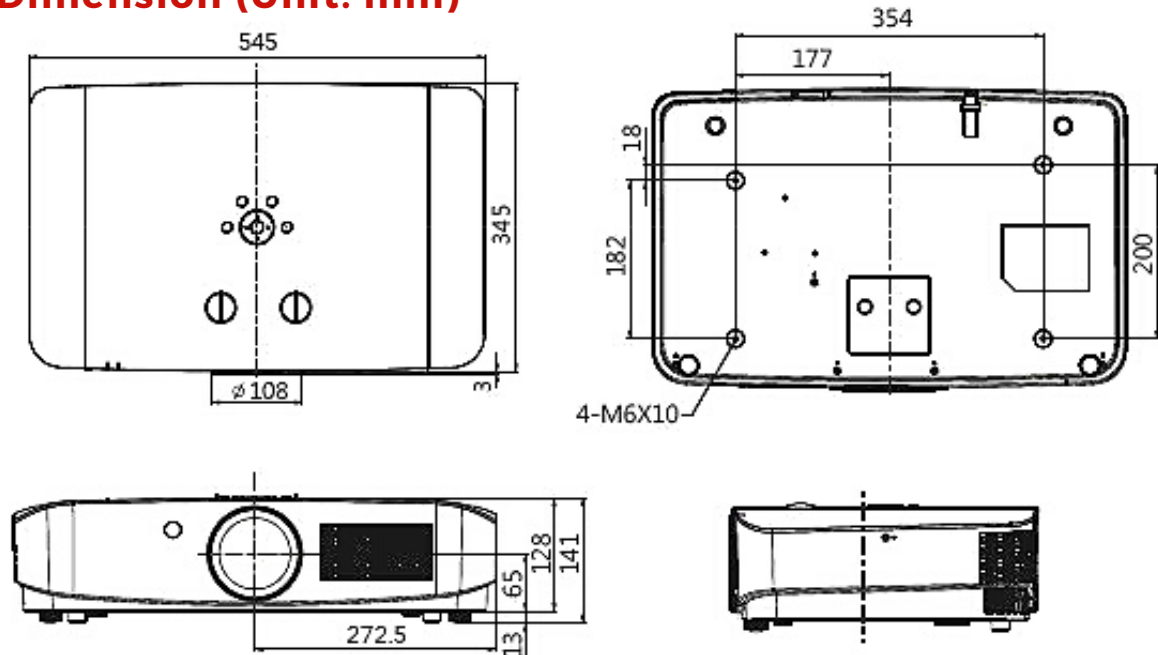

*Specifications and the product's design are subject to change without notice.

** Brightness specification may vary dependent upon lens throw ratio

*** Registration for 6th & 7th year warranty is required.

