

Specifications

Display Technology	Liquid Crystal Display
LCD Panel	3x0.64" (16:10)
Brightness (ISO lumens)	5500 Lumens
Resolution	WUXGA (1920 x 1200)
Number of pixels	2,304,000 (1920 x 1200)x3, total of 6,912,000 pixels
Contrast	3500000:1
Center to corner uniformity	> 90%
Lens	F2.0~2.16, f=9.77~11.32mm, Manual zoom (1.2x), Manual focus
Screen size	60"-300"
Throw distance	0.86m~5.16m
Throw Ratio	0.68~0.80
Light Source (Service life)	Laser diode (Normal mode: 20000h, Eco mode: 25000h)
Lens Shift	Up:35% (Manual), Down: 5% (Manual), Horizontal: ±10% (Manual)
Keystone Correction	Vertical: ±40° (Auto, Manual), Horizontal: ±15° (Manual)
Input Terminals	PC: DVI-D x1, VGA (D-sub 15pin)x1 Audio: Audio in: mini jack x1 (3.5mm) Video: HDMI x1, Video x1 (RCA) Other: USB x2
Output Terminals	VGA (D-sub 15pin) x1, Audio out (Mini-jack) x1 (3.5mm)
Control Terminals	Rs232 (D-sub 9pin) x1, RJ-45 x1 (Control)
PC input signal	PC-VGA, SVGA, XGA, SXGA, WXGA, UXGA, WUXGA / Mac
Video input signal	PAL, SECAM, NTSC (480i, 480p, 576i, 576p, 720p, 1080i, 1080p)
Scanning Frequency	Horizontal: 15~90kHz, Vertical: 24~85Hz
Noise	Normal mode: 37dB, Eco mode: 29dB
Projection Method	Ceiling/floor, front/rear (Auto Image Rotation)
Speaker	10W x 1
Weight	11 Kg
Dimension (WxHxD)	545 x 135 x 345mm (not incl. protruded part)
Power Consumption	100~240V AC (50/60Hz)
Standby power consumption	460W max (≤ 0.5W when standby mode set to Eco)
Operating Environment	Operating temperature: 0°C~40°C, Operating Humidity: 20%~80% (non-condensation)
Standard accessory	Wireless remote control, power cord
Functions	<ul style="list-style-type: none"> Built-in LAN for remote monitoring DICOM simulation mode Overheat automatic shutdown function Quick start and Quick off One-button black screen function Quiet 29dB (Eco mode) Compatible with PJ-Link `AMX` Crestron Password locking and anti-theft lock latch Blackboard modes for colored screen surfaces USB Memory



VIN-U6A-S

Specifications Sheet

Projection Distance

XGA (4:3 aspect ratio)

Screen Size (inch)	Min. (wide)(meter)	Max. (tele)(meter)
60"	0.88	1.04
100"	1.49	1.75
120"	1.80	2.11
150"	2.26	2.65
200"	3.03	3.55
300"	4.45	5.30

WXGA (16:10 aspect ratio)

60"	0.86	1.02
80"	1.47	1.73
100"	1.77	2.08
150"	2.22	2.61
200"	2.98	3.09
300"	4.32	5.16

WUXGA (16:10 aspect ratio)

60"	0.86	1.02
100"	1.47	1.73
120"	1.77	2.08
150"	2.22	2.61
200"	2.98	3.09
300"	4.32	5.16



Dimension (Unit: mm)

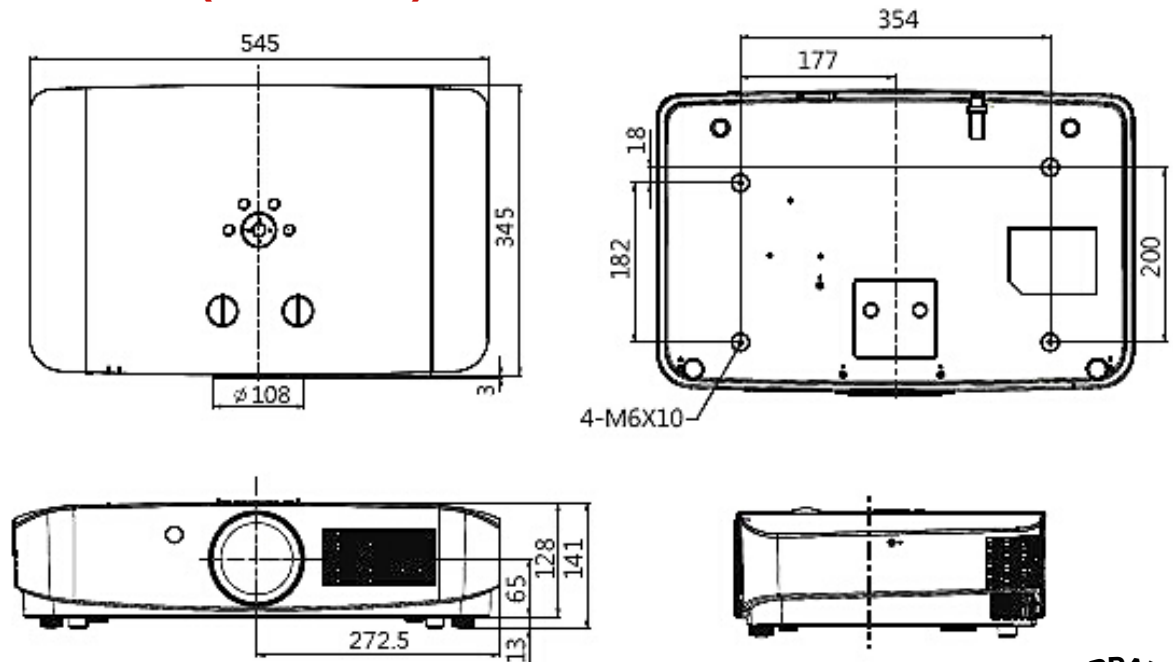

*Specifications and the product's design are subject to change without notice.

** Brightness specification may vary dependent upon lens throw ratio

*** Registration for 6th & 7th year warranty is required.

